

配件 (Accessories)

類別 (Category)	說明 (Description)	編號 (Parts No.)	外觀 (Illustration)	類別 (Category)	說明 (Description)	編號 (Parts No.)	外觀 (Illustration)		
鑰匙 (Spare Key)	NO. 001 標準型 (Standard)	61-024-01		銘板 (ADA 16E Yellow Legend Plate)	英語 緊急停止 (English Emergency stop Identity plate)	60-025-01			
	客製化 (Custom)	NO. 002			61-024-02	絕緣端子套 (C1S Isolation Cover)	保護端子套 (Protective Cover)	60-025-02	
		NO. 003			61-024-03			BS05-013	
		NO. 004			61-024-04				
		NO. 005			61-24-05				
	NO. 006	61-24-06							
安裝孔塞 (Blanking Plate Block)	圓形遮掩預備安裝孔 (Round PVC stopper to stuff the superfluous hole of the panel board)	50-013-01		長方形平面鑲嵌框 (ADA 16S Flush Mounted Type Rectangular Bezel)	面板厚度 0.5-5mm (Fit panel thickness 0.5-5mm)	60-022-07			
	方形遮掩預備安裝孔 (Square PVC stopper to stuff the superfluous hole of the panel board)	50-013-03			面板厚度 3-7mm (Fit panel thickness 3-7mm)	60-022-17			
鎖緊扳手 (Mounting Rench)	緊固鎖緊環用 (Use this for tightening the switch in the mounting hole)	50-006-01		正方形平面鑲嵌框 (ADA 16S Flush Mounted Type Square Bezel)	面板厚度 6-10mm (Fit panel thickness 6-10mm)	60-022-27			
		BS04-022			面板厚度 0.5-5mm (Fit panel thickness 0.5-5mm)	60-023-07			
		BS04-022-05			面板厚度 3-7mm (Fit panel thickness 3-7mm)	60-023-17			
鎖緊環 (Fixing Nut)	固定面板上之按鈕 (Fixing housings on panel)	BS04-018		圓形方形平面鑲嵌框 (ADA 16S Flush Mounted Type Square Bezel)	面板厚度 6-10mm (Fit panel thickness 6-10mm)	60-023-27			
		BS93-049			面板厚度 0.5-5mm (Fit panel thickness 0.5-5mm)	60-021-07			
接線端子 (Connector)	用於 2.8 X 0.5mm 之絕緣插座 (Insulation Socket 2.8 X 0.5mm)	50-014-01		圓形方形平面鑲嵌框 (ADA 16S Flush Mounted Type Square Bezel)	面板厚度 3-7mm (Fit panel thickness 3-10mm)	60-021-17			
燈罩拆卸工具 (Lens Removing)	拆卸燈罩用 (Use this for replaced the fitting color lens)	50-007-01			面板厚度 6-10mm (Fit panel thickness 6-10mm)	60-021-27			
燈泡更換工具 (Lamp Extractor)	拆卸燈泡工具 (Removing lamp tool)	61-016							

配件 (Accessories)

類別 (Category)	說明 (Description)	編號 (Parts No.)	外觀 (Illustration)	類別 (Category)	說明 (Description)	編號 (Parts No.)	外觀 (Illustration)
長方形面框膠圈 (Rectangular Gasket)	與長方形面框及方形固定壓板一起使用，用於平面鑲嵌 (Used with rectangular bezel and square mounting bracket)	BR04-W05		方形固定壓板 (Square Mounting Bracket)	用於平面鑲嵌 高 12 mm (Used with flush bezel height 12 mm)	BS03-W09	
長方形面框 (Rectangular Bezel)	與長方形面框膠圈及方形固定壓板一起使用，用於平面鑲嵌 (Used with rectangular Gasket and square mounting bracket)	BS01-W19			用於平面鑲嵌 高 9 mm (Used with flush bezel height 9 mm)	BS03-W11	
正方形面框膠圈 (Square Gasket)	與正方形面框及方形固定壓板一起使用，用於平面鑲嵌 (Used with square bezel and square mounting bracket)	BR04-W04			用於平面鑲嵌 高 6 mm (Used with flush bezel height 6 mm)	BS03-C06	
正方形面框 (Square Bezel)	與正方形面框膠圈及方形固定壓板一起使用，用於平面鑲嵌 (Used with square gasket and square mounting bracket)	BS01-W18		圓形固定套環 (Round Mounting Bracket)	用於平面鑲嵌 高 12 mm (Used with flush bezel height 12 mm)	BS01-W17	
圓形面框膠圈 (Round Gasket)	與圓形面框及圓形固定套環一起使用，用於平面鑲嵌 (Used with round bezel and round mounting bracket)	BR04-W03			用於平面鑲嵌 高 9 mm (Used with flush bezel height 9 mm)	BS01-W21	
圓形面框 (Round Bezel)	與圓形面框膠圈及圓形固定套環一起使用，用於平面鑲嵌 (Used with round gasket and round mounting bracket)	BS01-W16			用於平面鑲嵌 高 6 mm (Used with flush bezel height 6 mm)	BS01-W34	
PC 板插座 (PC Board Terminal)	接於 C1 系列控制元件末端 (Plugs on the rear of the C1 series control units)	61-015-01		鍍錫式插座 (Solder Terminal)	接於 C1 系列控制元件末端 (Plugs on the rear of the C1 series control units)	61-015-02	

■ 外型尺寸圖 (Dimensions) (mm)

• 插座 (Socket)

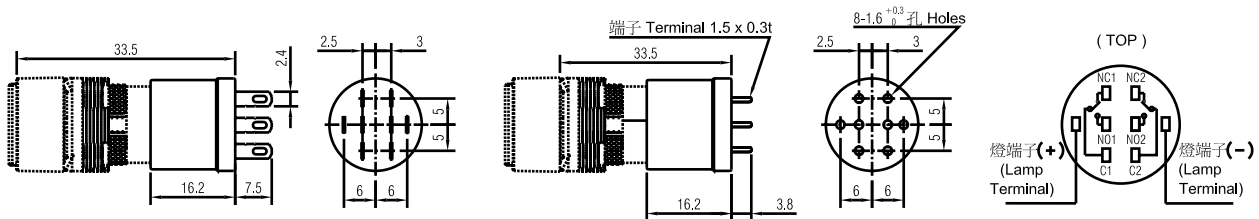

配件 (Accessories)

△ 平面鑲嵌框安裝至面板時

- 首先請從操作部上拆下鎖緊環與防轉固定板。
- 將鑲嵌框組裝到操作部上，安裝到面板的安裝孔內，然後安裝鑲嵌框附帶的防轉固定板，最後用鎖緊環鎖緊。(無需用操作部上附帶的防轉固定板)。請將圓形元件用鑲嵌框的突起與操作部 TOP 標誌方向的槽對齊後插入組裝。

△ Panel Mounting of Flush Bezels

- Remove the locking ring and anti-rotation ring from the operator.
- Attach the flush bezel to the operator. Then insert the assembly into the panel. Attach the mounting bracket and tighten the locking ring. (Do not use the anti-rotation ring supplied with the operator.)
- Insert the contact block, with the TOP markings on the contact block and the operator placed in the same direction. Then lock the units, turning the locking lever in the direction of the arrow.

■ 外型尺寸圖 (Dimensions) (mm)

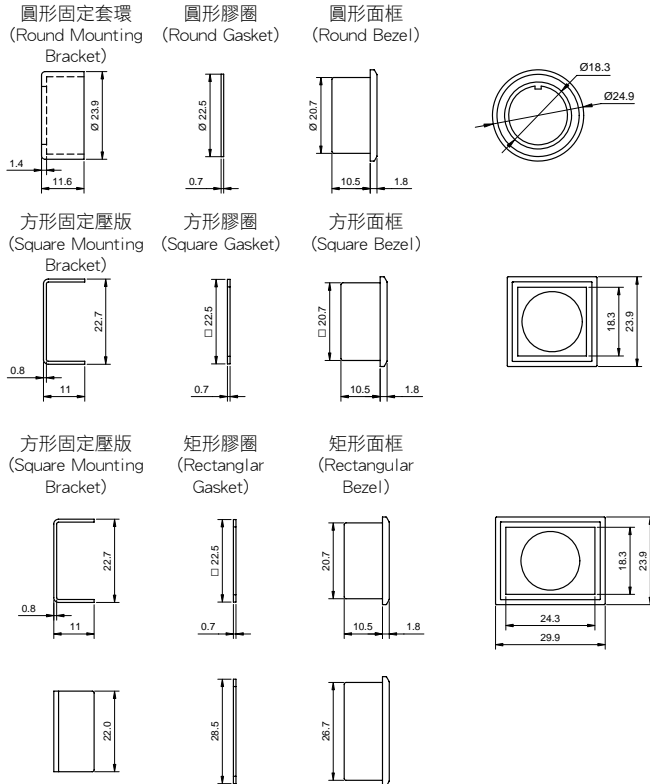

■ 組合方式 (Installing)

- 將開關拆開成零件 (Remove parts from switches.)
 A: 本體 (Main Part) B: 橡膠墊圈 (Rubber Gasket)
 C: 防轉板 (Anti-rotation Ring) (組合時不使用 Do not install)
 D: 鎖緊環 (Lock Ring)

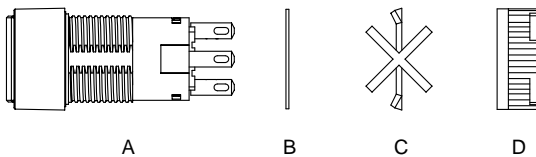

- 配合鑲嵌框配件組合，其中 C 零件不再使用 (Combine with bezel, gasket, and mounting bracket. Do not use part C.)
 E: 面框 (Bezel) F: 面框膠圈 (Gasket)
 G: 固定壓板 (套環) (Mounting Bracket)

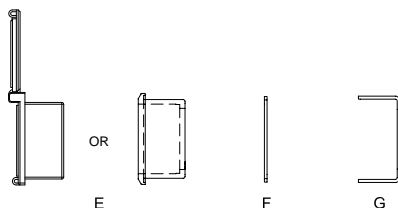

■ 安裝控制元件 (Control Unit)

選擇開關 (Selector Switches)

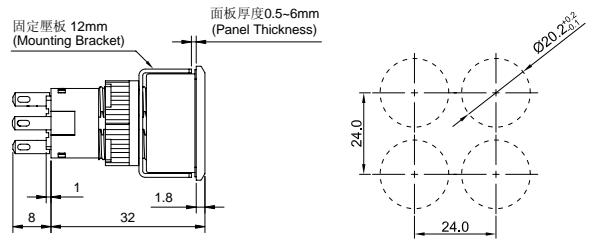

照光選擇開關 (Illuminated Selector Switches)

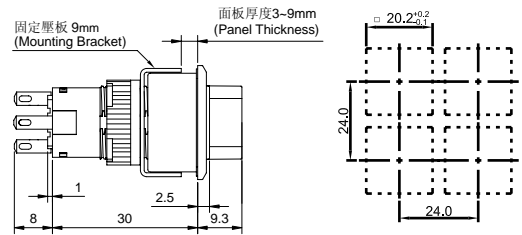

鑰匙選擇開關 (Key Selector Switches)

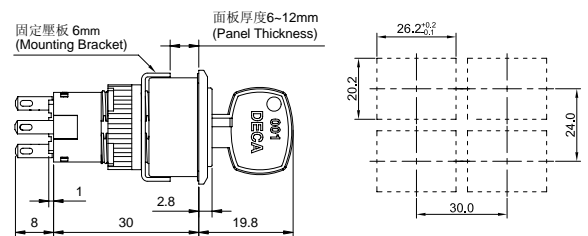

3. 組合形式 (Installing)

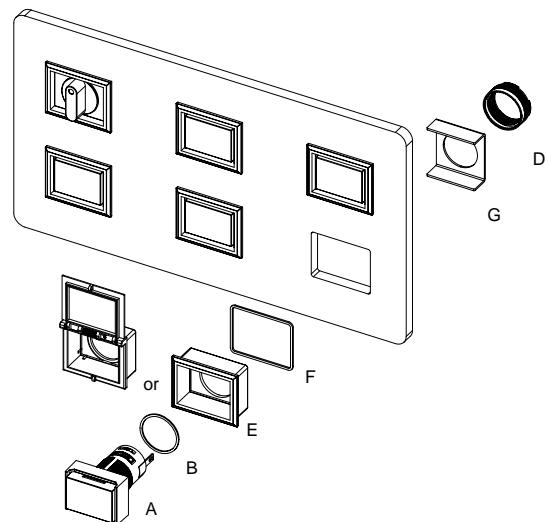

配件 (Accessories)

類別 (Category)	說明 (Description)	編號 (Parts No.)	外觀 (Illustration)	
IP65 開關保護罩 (Switch Guard)	180° 開閉彈簧復歸型 (180° spring return opening type)	圓形用 (For Round Units)	60-011-36	
		正方形用 (For Square Units)	60-011-32	
		長方形用 (For Rectangular Units)	60-011-31	

△ 護罩型平面鑲嵌框的安裝

△ Panel Mounting of Flush Bezels with Switch Guard

■ 外型尺寸圖 (Dimensions) (mm)

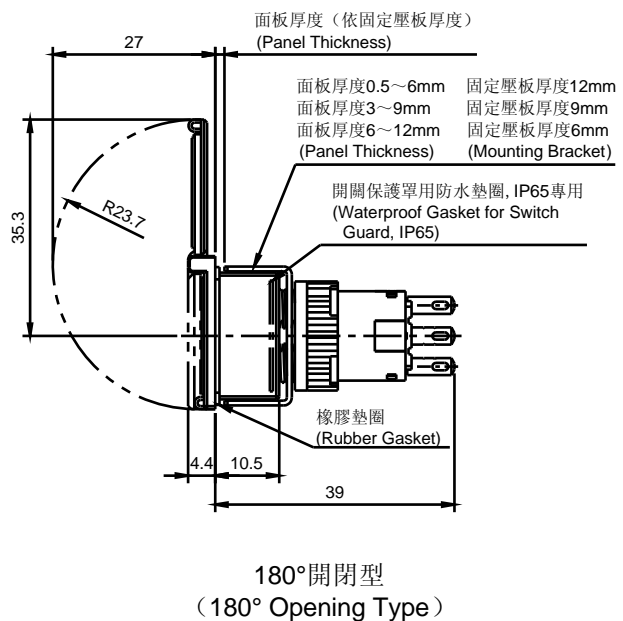
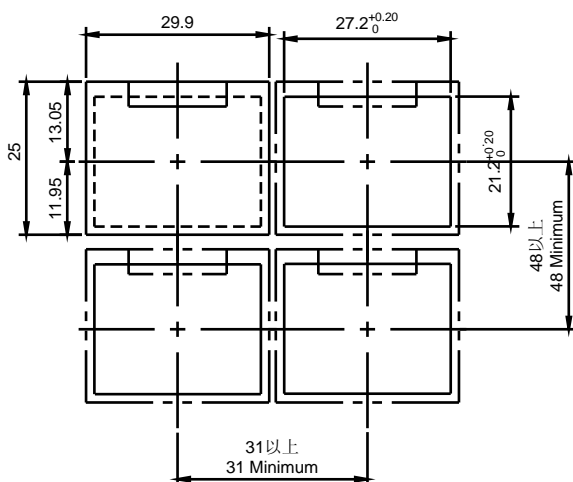
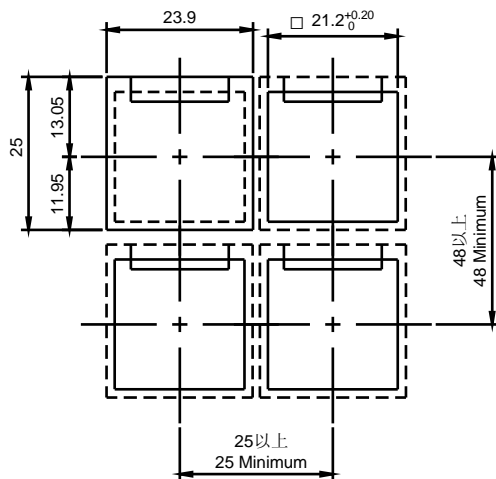
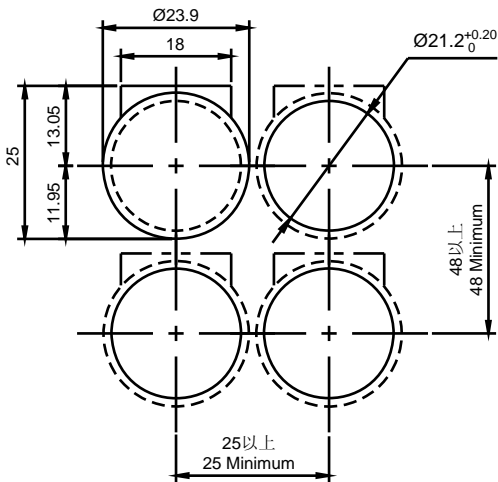

· 開關保護罩 (保護構造: IP40, IP65) (Switch Guard, Degree of Protection: IP40, IP65)



* 組合方式參閱 P61(Please refer to page 61)

配件 (Accessories)

配件

類別 (Category)	說明 (Description)		編號 (Parts No.)	外觀 (Illustration)	類別 (Category)	說明 (Description)		編號 (Parts No.)	外觀 (Illustration)
IP40 開關保護罩 (Switch Guard)	90° 開閉自己保持型 (90° alternate opening type)	圓形 / 正方形用 (For Round/Square Units)	50-011-01		IP65 開關保護罩 (Switch Guard)	90° 開閉自己保持型 (90° alternate opening type)	圓形 / 正方形用 (For Round/Square Units)	60-011-01	
		長方形用 (For Rectangular Units)	50-011-02				長方形用 (For Rectangular Units)	60-011-02	
	180° 開閉自己保持型 (180° alternate opening type)	圓形 / 正方形用 (For Round/Square Units)	50-011-11			180° 開閉自己保持型 (180° alternate opening type)	圓形 / 正方形用 (For Round/Square Units)	60-011-11	
		長方形用 (For Rectangular Units)	50-011-12				長方形用 (For Rectangular Units)	60-011-12	

△ 護罩型平面鑲嵌框的安裝

△ Panel Mounting of Flush Bezels with Switch Guard

■ 外型尺寸圖 (Dimensions) (mm)

· 開關保護罩 (保護構造 : IP40, IP65) (Switch Guard, Degree of Protection: IP40, IP65)

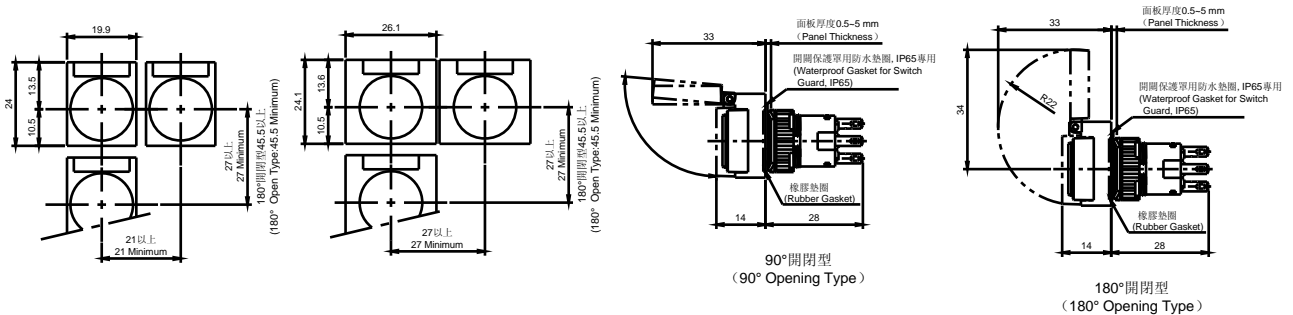

■ 組合方式 (Installing)

1. 將開關拆開成零件 (Remove parts from switches.)

A: 本體 (Main Part)

B: 橡膠墊圈 (Rubber Gasket)

C: 防轉板 (Anti-rotation Ring)

D: 鎖緊環 (Lock Ring)

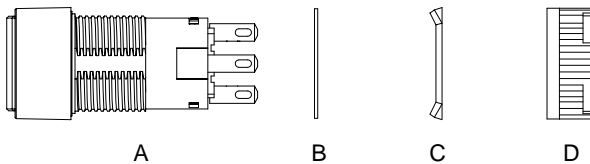

3. 組合形式 (Installing)

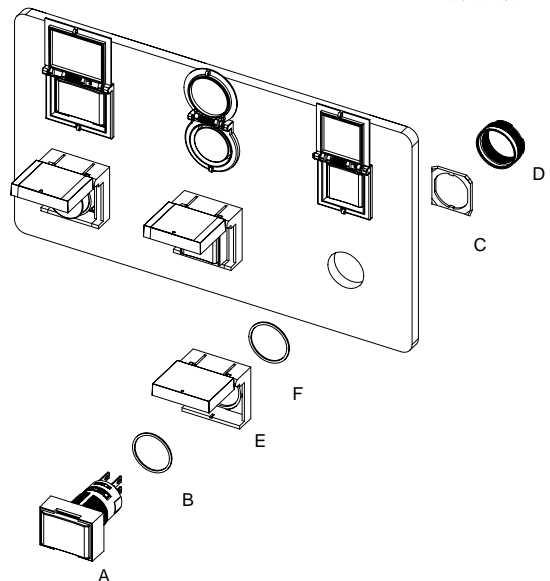

2. 配合鑲嵌框配件組合 (Combine with bezel, gasket, and mounting bracket.)

E: 面框 (Bezel)

F: 面框膠圈 (Gasket)

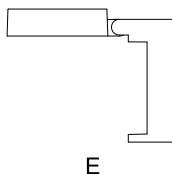

配件 (Accessories)

■ 安裝孔加工圖、最小安裝中心間距 (Mounting Hole Layout) (mm)

- 大型按鈕開關 - 圓形、正方形
Oversized Pushbuttons-Round, Square (C1S04、C1S09、C1S-M1、C1S-A2)

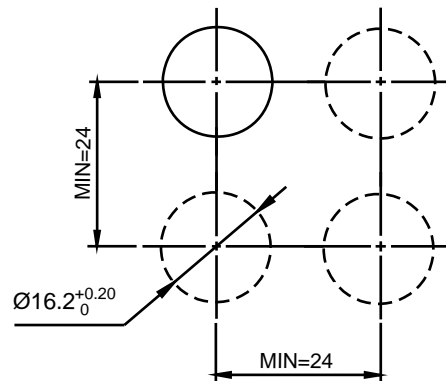

- 一般按鈕開關 - 圓形、正方形
Pushbuttons-Round, Square (C1S-R1、C1S-S2)
- 選擇開關 - 圓形、正方形
Selector Switches-Round, Square (C1C-R5、C1C-S5)
- 鑰匙選擇開關 - 圓形、正方形
Key Selector Switches-Round, Square (C1K-R5、C1K-S5)
- 指示燈 - 圓形、正方形
Pilot Lights-Round, Square (C1P-R1、C1P-S2)
- 蜂鳴器 - 圓形、正方形
Buzzer-Round, Square (C1B-R1、C1B-S2)

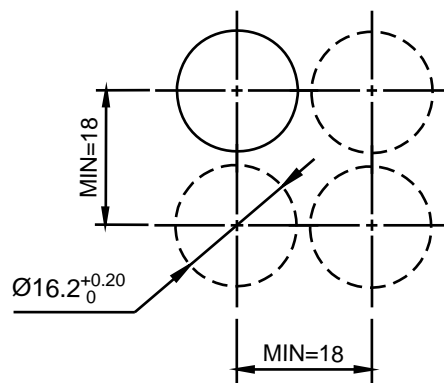

- 大型按鈕開關 - 長方形
Oversized Pushbuttons-Rectangular (C1S-B2)
- 一般按鈕開關 - 長方形
Pushbuttons-Rectangular (C1S-T2、C1S-T5)
- 選擇開關 - 長方形
Selector Switches-Rectangular (C1C-T5)
- 鑰匙選擇開關 - 長方形
Key Selector Switches-Rectangular (C1K-T5)
- 指示燈 - 長方形
Pilot Lights-Rectangular (C1P-T2)
- 蜂鳴器 - 長方形
Buzzer-Rectangular (C1B-T2)

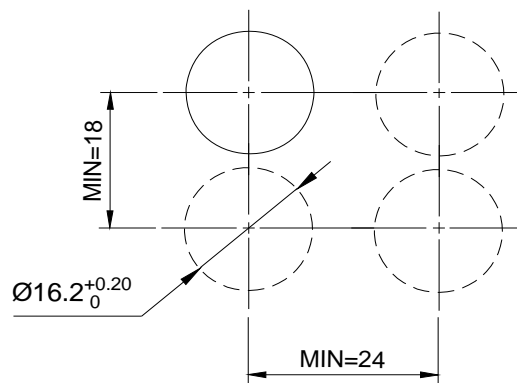

■ 絕緣端子套 (Terminal Cover)

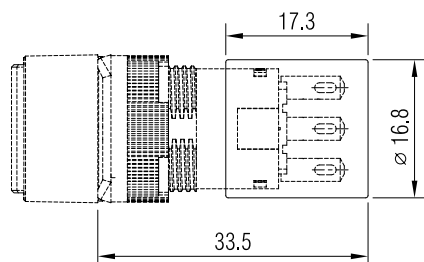

註：接線時，請先將導線插入絕緣端子套的孔中，再焊接。
(Note: When wiring the terminals, insert the lead wires into the terminal cover holes before soldering.)





















配件 (Accessories)

名稱 (Name)	圓形按鈕 (Round Pushbuttons) 用於按鈕開關 (For Pushbuttons)					
顏色 (Colors)	藍色 (Blue)	綠色 (Green)	紅色 (Red)	黃色 (Yellow)	黑色 (Black)	白色 (White)
型號 (Type No.)	61-001-21	61-001-22	61-001-24	61-001-26	61-001-27	61-001-28
外觀 (Illustration)						
名稱 (Name)	正方形按鈕 (Square Pushbuttons) 用於按鈕開關 (For Pushbuttons)					
顏色 (Colors)	藍色 (Blue)	綠色 (Green)	紅色 (Red)	黃色 (Yellow)	黑色 (Black)	白色 (White)
型號 (Type No.)	61-003-21	61-003-22	61-003-24	61-003-26	61-003-27	61-003-28
外觀 (Illustration)						
名稱 (Name)	長方形按鈕 (Rectangular Pushbuttons) 用於按鈕開關 (For Pushbuttons)					
顏色 (Colors)	藍色 (Blue)	綠色 (Green)	紅色 (Red)	黃色 (Yellow)	黑色 (Black)	白色 (White)
型號 (Type No.)	61-002-21	61-002-22	61-002-24	61-002-26	61-002-27	61-002-28
外觀 (Illustration)						

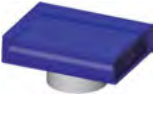

















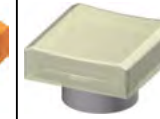

配件 配件 (Accessories)

名稱 (Name)	大圓形按鈕 (Oversized Round Pushbuttons) 用於按鈕開關 (For Pushbuttons)					
顏色 (Colors)	藍色 (Blue)	綠色 (Green)	紅色 (Red)	黃色 (Yellow)	黑色 (Black)	白色 (White)
型號 (Type No.)	61-011-21	61-011-22	61-011-24	61-011-26	61-011-27	61-011-28
外觀 (Illustration)						
名稱 (Name)	大正方形按鈕 (Oversized Square Pushbuttons) 用於按鈕開關 (For Pushbuttons)					
顏色 (Colors)	藍色 (Blue)	綠色 (Green)	紅色 (Red)	黃色 (Yellow)	黑色 (Black)	白色 (White)
型號 (Type No.)	61-013-21	61-013-22	61-013-24	61-013-26	61-013-27	61-013-28
外觀 (Illustration)						
名稱 (Name)	大長方形按鈕 (Oversized Rectangular Pushbuttons) 用於按鈕開關 (For Pushbuttons)					
顏色 (Colors)	藍色 (Blue)	綠色 (Green)	紅色 (Red)	黃色 (Yellow)	黑色 (Black)	白色 (White)
型號 (Type No.)	61-012-21	61-012-22	61-012-24	61-012-26	61-012-27	61-012-28
外觀 (Illustration)						

















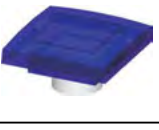

配件 (Accessories)

名稱 (Name)	圓形燈罩 (Round Lens) 用於指示燈 (For Pilot Lights)						
顏色 (Colors)	藍色 (Blue)	綠色 (Green)	橘色 (Orange)	紅色 (Red)	純白色 (Pure White)	黃色 (Yellow)	乳白色 (White)
型號 (Type No.)	60-001-31	60-001-32	60-001-33	60-001-34	60-001-35	60-001-36	60-001-38
外觀 (Illustration)							
名稱 (Name)	正方形燈罩 (Square Lens) 用於指示燈 (For Pilot Lights)						
顏色 (Colors)	藍色 (Blue)	綠色 (Green)	橘色 (Orange)	紅色 (Red)	純白色 (Pure White)	黃色 (Yellow)	乳白色 (White)
型號 (Type No.)	60-003-31	60-003-32	60-003-33	60-003-34	60-003-35	60-003-36	60-003-38
外觀 (Illustration)							
名稱 (Name)	長方形燈罩 (Rectangular Lens) 用於指示燈 (For Pilot Lights)						
顏色 (Colors)	藍色 (Blue)	綠色 (Green)	橘色 (Orange)	紅色 (Red)	純白色 (Pure White)	黃色 (Yellow)	乳白色 (White)
型號 (Type No.)	60-002-31	60-002-32	60-002-33	60-002-34	60-002-35	60-002-36	60-002-38
外觀 (Illustration)							

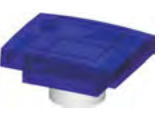
配件 配件 (Accessories)

名稱 (Name)	圓形燈罩 (Round Lens) 用於照光按鈕開關 (For Illuminated Pushbuttons)						
顏色 (Colors)	藍色 (Blue)	綠色 (Green)	橘色 (Orange)	紅色 (Red)	純白色 (Pure White)	黃色 (Yellow)	乳白色 (White)
型號 (Type No.)	60-001-21	60-001-22	60-001-23	60-001-24	60-001-25	60-001-26	60-001-28
外觀 (Illustration)							
名稱 (Name)	正方形燈罩 (Square Lens) 用於照光按鈕開關 (For Illuminated Pushbuttons)						
顏色 (Colors)	藍色 (Blue)	綠色 (Green)	橘色 (Orange)	紅色 (Red)	純白色 (Pure White)	黃色 (Yellow)	乳白色 (White)
型號 (Type No.)	60-003-21	60-003-22	60-003-23	60-003-24	60-003-25	60-003-26	60-003-28
外觀 (Illustration)							
名稱 (Name)	長方形燈罩 (Rectangular Lens) 用於照光按鈕開關 (For Illuminated Pushbuttons)						
顏色 (Colors)	藍色 (Blue)	綠色 (Green)	橘色 (Orange)	紅色 (Red)	純白色 (Pure White)	黃色 (Yellow)	乳白色 (White)
型號 (Type No.)	60-002-21	60-002-22	60-002-23	60-002-24	60-002-25	60-002-26	60-002-28
外觀 (Illustration)							

配件 (Accessories)













名稱 (Name)	大圓形燈罩 (Oversized Round Lens) 用於照光按鈕開關 (For Illuminated Pushbuttons)						
顏色 (Colors)	藍色 (Blue)	綠色 (Green)	橘色 (Orange)	紅色 (Red)	純白色 (Pure White)	黃色 (Yellow)	乳白色 (White)
型號 (Type No.)	61-011-211	61-011-221	61-011-231	61-011-241	61-011-251	61-011-261	61-011-281
外觀 (Illustration)							
名稱 (Name)	大正方形燈罩 (Oversized Square Lens) 用於照光按鈕開關 (For Illuminated Pushbuttons)						
顏色 (Colors)	藍色 (Blue)	綠色 (Green)	橘色 (Orange)	紅色 (Red)	純白色 (Pure White)	黃色 (Yellow)	乳白色 (White)
型號 (Type No.)	61-013-211	61-013-221	61-013-231	61-013-241	61-013-251	61-013-261	61-013-281
外觀 (Illustration)							
名稱 (Name)	大長方形燈罩 (Oversized Rectangular Lens) 用於照光按鈕開關 (For Illuminated Pushbuttons)						
顏色 (Colors)	藍色 (Blue)	綠色 (Green)	橘色 (Orange)	紅色 (Red)	純白色 (Pure White)	黃色 (Yellow)	乳白色 (White)
型號 (Type No.)	61-012-211	61-012-221	61-012-231	61-012-241	61-012-251	61-012-261	61-012-281
外觀 (Illustration)							

配件 配件 (Accessories)

名稱 (Name)	旋鈕 (Knob Operator) 用於選擇開關 (For Selector Switches)						
顏色 (Colors)	藍色 (Blue)	綠色 (Green)	紅色 (Red)	黃色 (Yellow)	黑色 (Black)	白色 (White)	
型號 (Type No.)	61-016-11	61-016-12	61-016-14	61-016-16	61-016-17	61-016-18	
外觀 (Illustration)							
名稱 (Name)	旋鈕 (Knob Operator) 用於照光選擇開關 (For Illuminated Selector Switches)						
顏色 (Colors)	藍色 (Blue)	綠色 (Green)	橘色 (Orange)	紅色 (Red)	純白色 (Pure White)	黃色 (Yellow)	乳白色 (White)
型號 (Type No.)	61-016-111	61-016-121	61-016-131	61-016-141	61-016-151	61-016-161	61-016-181
外觀 (Illustration)							

配件 (Accessories)

配件

名稱 (Name)	6V AC/DC LED 燈泡 (6V AC/DC LED Lamps) 用於 C1 系列 (For C1 Series)					
顏色 (Colors)	藍色 (Blue)	綠色 (Green)	橘色 (Orange)	紅色 (Red)	黃色 (Yellow)	白色 (White)
型號 (Type No.)	LCTD-6B	LCTD-6G	LCTD-6O	LCTD-6R	LCTD-6Y	LCTD-6W
外觀 (Illustration)						
名稱 (Name)	12V AC/DC LED 燈泡 (12V AC/DC LED Lamps) 用於 C1 系列 (For C1 Series)					
顏色 (Colors)	藍色 (Blue)	綠色 (Green)	橘色 (Orange)	紅色 (Red)	黃色 (Yellow)	白色 (White)
型號 (Type No.)	LCTD-1B	LCTD-1G	LCTD-1O	LCTD-1R	LCTD-1Y	LCTD-1W
外觀 (Illustration)						
名稱 (Name)	24V AC/DC LED 燈泡 (24V AC/DC LED Lamps) 用於 C1 系列 (For C1 Series)					
顏色 (Colors)	藍色 (Blue)	綠色 (Green)	橘色 (Orange)	紅色 (Red)	黃色 (Yellow)	白色 (White)
型號 (Type No.)	LCTD-2B	LCTD-2G	LCTD-2O	LCTD-2R	LCTD-2Y	LCTD-2W
外觀 (Illustration)	