

C24K-23AE①

工業開關 > Φ22mm一體式開關

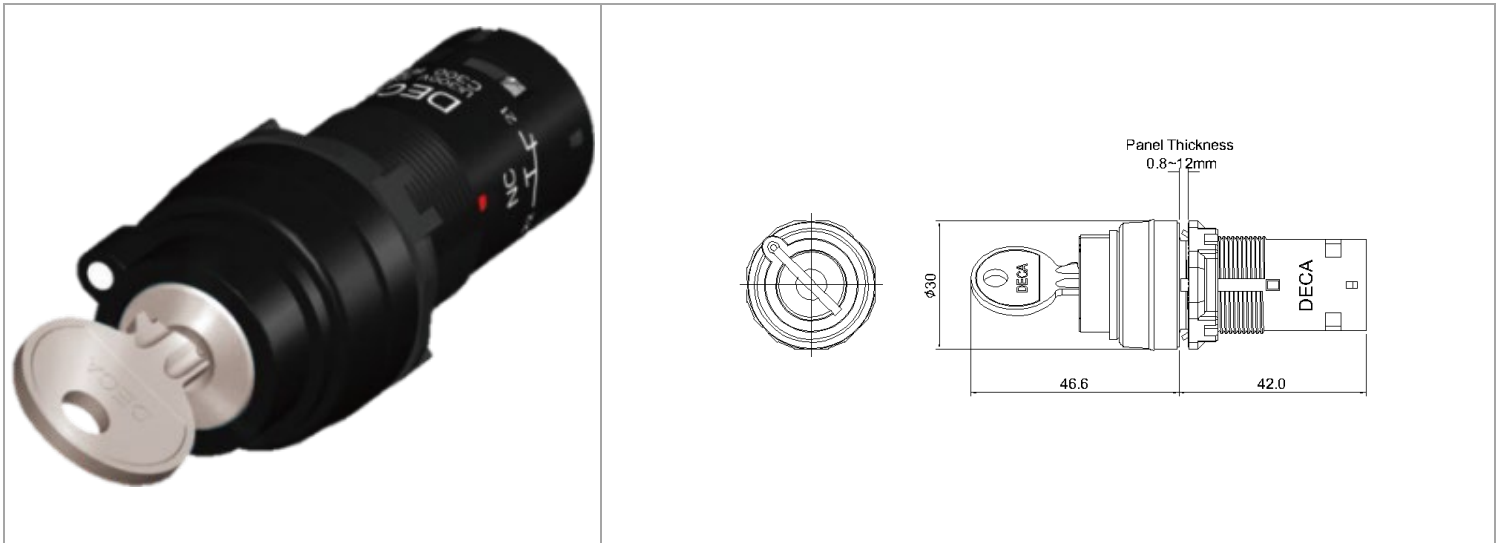

目錄僅供參考，實際規格仍依照產品工程圖面為準

產品介紹 Product Description

基本信息 Additional Information

產品系列 Series	M22
產品種類 Function	一體式 Compact
產品型式 Type	鑰匙開關 Key Selector Switch
面框材料 Bezel Material	金屬 Metal
產品動作 Action	2 Positions 0° to +45°
動作類型 Operator	保持 Maintained
鑰匙抽取 Key Removable	Key Removable in All Ways
接點塊 ① Block ①	10:1NO, 20: 2NO, 01:1NC, 02:2NC, 11:1NO+1NC
重量 Weight	27g
線徑 Wire Diameter	16~22AWG

產品規格 Product Specification

Rated Insulation Voltage (Ui)		300V			
Rated Thermal Current (Ith)		8A			
Rated Operational Voltage (Ue)		12V	30V	125V	250V
AC 50/60HZ	Resistive Load (AC-12) (Ie)	5A	5A	4A	2A
	Inductive Load (AC-15) (Ie)	5A	5A	3A	1.5A
DC	Resistive Load (DC-12) (Ie)	1A	1A	0.32A	0.16A
	Inductive Load (DC-13) (Ie)	1A	1A	0.22A	0.11A
儲存溫度 Storage Temperature	-45°C to +85°C				
操作溫度 Operating Temperature	-25°C to +70°C				
操作濕度 Operating Humidity	45% to 85% RH				
防護等級 Degree of Protection	IP66				

汙染等級 Degree of Pollution	3
接觸阻抗 Contact resistance	100mΩ max (at 1A, DC 6~8V)
絕緣阻抗 Insulation resistance	100MΩ max (at DC 500V)
耐電壓 Dielectric Strength	AC 2000, 50/60Hz for 1min
機械壽命 Mechanical Life	500,000 operations
電氣壽命 Electrical Life	100,000 operations
電氣耐久性 Electrical Durability	1,000,000 cycles, AC-15, 230V/1A, 3600 cyc/hr, load factor 0.5 1,000,000 cycles, DC-13, 24V/0.6A, 3600 cyc/hr, load factor 0.5
抗衝擊-誤動作 Shock Resistance - Operating Extremes	100 m/s ²
抗衝擊-耐久性 Shock Resistance - Operating Extremes	1000 m/s ²
耐振動-誤動作 Vibration Resistance - Operating Extremes	5~55Hz, 單振幅 0.5mm 5 to 55Hz, Amplitude 0.5mm
耐振動-耐久性 Vibration Resistance - Damage Limits	30Hz, 單振幅 1.5mm 30Hz, Amplitude 1.5mm
容許操作頻率-機械 Operating Frequency	瞬時MAX 60次/min (參考) Instantaneous Maximun 60 operations per 1 min

安裝說明 Assembly

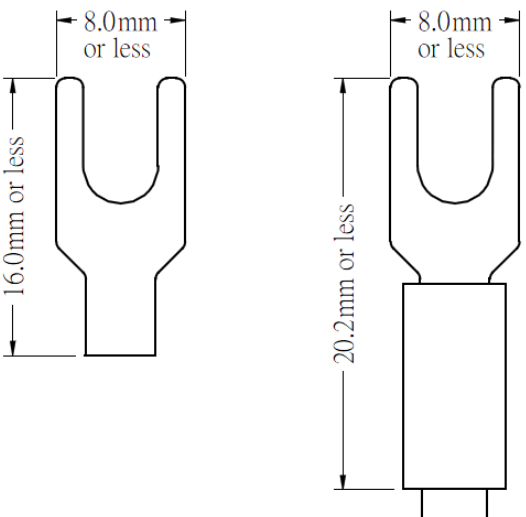
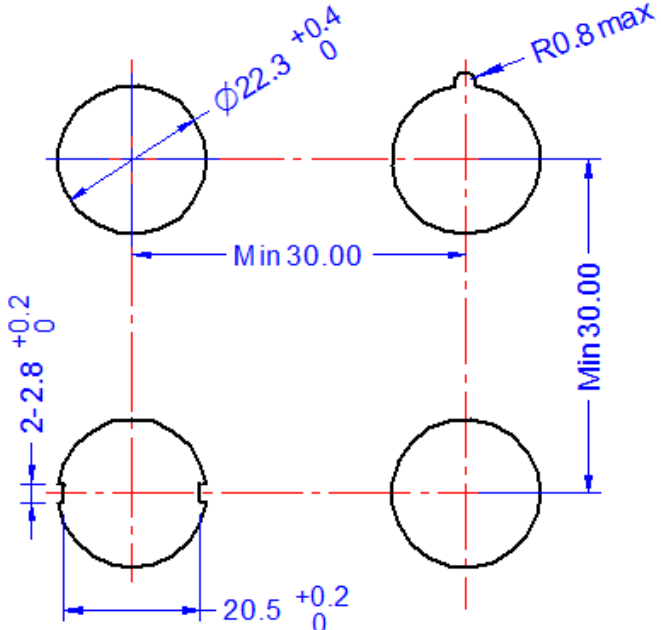
端子外型 Crimp Terminals Appearance	安裝孔尺寸 Mounting Hole Layout
	
面板厚度 Panel Thickness	0.8~12 mm
安裝轉矩 (牙環) Mounting Torque	2 N.m

安全認證 Certificates

Certification Mark	 The image shows three certification marks: the CCC (China Compulsory Certification) logo, the CE (Conformité Européenne) logo, and the RoHS (Restriction of Hazardous Substances) logo. The RoHS logo includes the text 'RoHS Compliant'.
Approved StandardS	IEC 60947-5, GB/T 14048.5, GB/T 6994(IEC 60092)