

CP2E-T3E①R

工業開關 > Φ22AP2開關控制元件

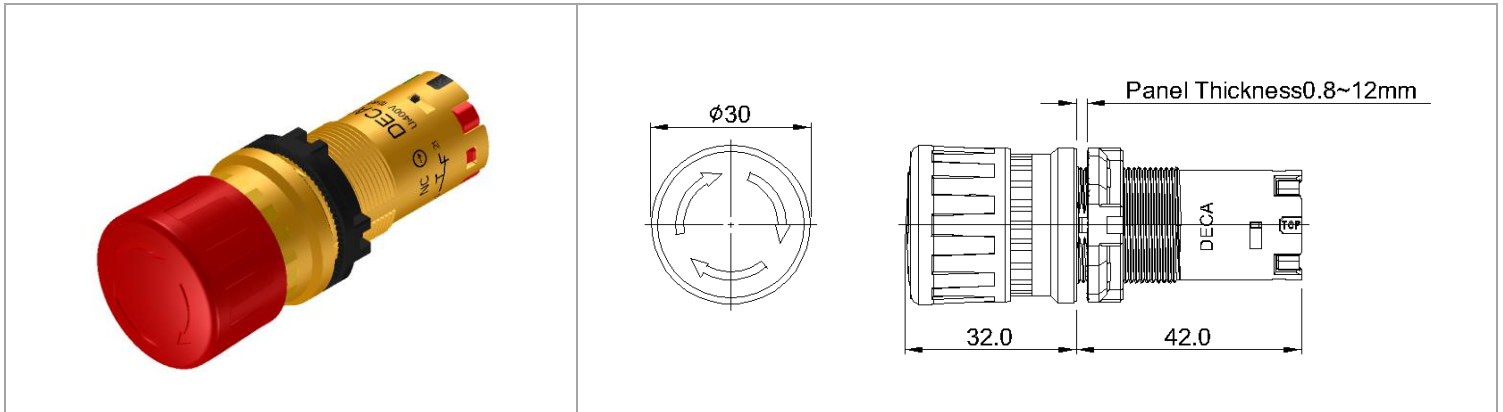

目錄僅供參考，實際規格仍依照產品工程圖面為準

產品介紹 Product Description

基本信息 Additional Information

產品系列 Series	M22
產品種類 Function	一體式 Compact
產品型式 Type	緊急停止開關 Emergency Stop Switch
面框材料 Bezel Material	塑膠 Plastic
頭框尺寸 Head Size	30 mm
動作類型 Operator	右旋解除 Rotate Release
接點塊 ① Block ①	10:1NO, 20: 2NO, 01:1NC, 02:2NC, 11:1NO+1NC
重量 Weight	27g
線徑 Wire Diameter	16~22AWG

產品規格 Product Specification

Rated Insulation Voltage (Ui)		400V				
Rated Thermal Current (Ith)		8A				
Rated Operational Voltage (Ue)		12V	30V	120V	240V	380V
AC 50/60HZ	Resistive Load (AC-12) (Ie)	8A	8A	8A	6A	3.8A
	Inductive Load (AC-15) (Ie)	8A	8A	6A	3A	1.9A
Rated Operational Voltage (Ue)		12V	30V	125V	250V	400V
DC	Resistive Load (DC-12) (Ie)	2.5A	2.5A	1.1A	0.55A	0.3A
	Inductive Load (DC-13) (Ie)	2.5A	2.3A	0.55A	0.27A	0.15A
儲存溫度 Storage Temperature		-45°C to +85°C				
操作溫度 Operating Temperature		-25°C to +70°C				
操作濕度 Operating Humidity		45% to 85% RH				
防護等級 Degree of Protection		IP66				



汙染等級 Degree of Pollution	3
接觸阻抗 Contact resistance	100mΩ max (at 1A, DC 6~8V)
絕緣阻抗 Insulation resistance	100MΩ max (at DC 500V)
耐電壓 Dielectric Strength	AC 2000, 50/60Hz for 1min
機械壽命 Mechanical Life	300,000 operations

電氣壽命 Electrical Life	100,000 operations
電氣耐久性 Electrical Durability	1,000,000 cycles, AC-15, 230V/1A, 3600 cyc/hr, load factor 0.5 1,000,000 cycles, DC-13, 24V/0.6A, 3600 cyc/hr, load factor 0.5
抗衝擊-誤動作 Shock Resistance - Operating Extremes	100 m/s ²
抗衝擊-耐久性 Shock Resistance - Operating Extremes	1000 m/s ²
耐振動-誤動作 Vibration Resistance - Operating Extremes	5~55Hz, 單振幅 0.5mm 5 to 55Hz, Amplitude 0.5mm
耐振動-耐久性 Vibration Resistance - Damage Limits	30Hz, 單振幅 1.5mm 30Hz, Amplitude 1.5mm
容許操作頻率-機械 Operating Frequency	瞬時MAX 60次/min Instantaneous Maximun 60 operations per 1 min

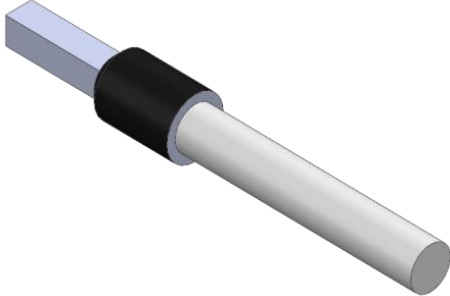
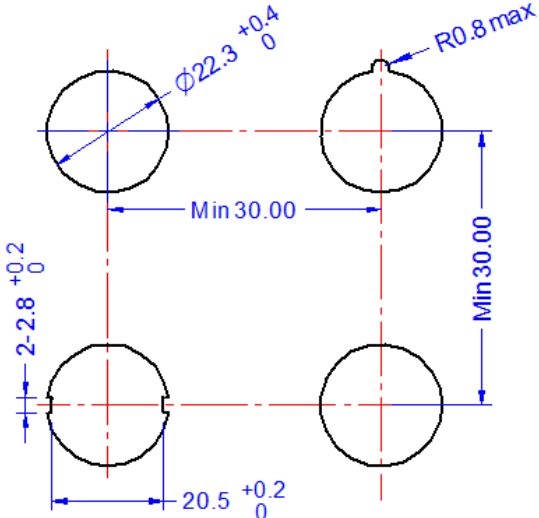
安裝說明 Assembly

端子外型 Crimp Terminals Appearance	安裝孔尺寸 Mounting Hole Layout
	
面板厚度 Panel Thickness	0.8~12 mm
安裝轉矩 (牙環) Mounting Torque	2 N.m

安全認證 Certificates

Certification Mark	    
Approved StandardS	IEC 60947-5, GB/T 14048.5, GB/T 6994(IEC 60092), UL1059, UL508(CSA C22.2 No.14).