

F24L1-N21xxDx002

工業開關 > 金屬指示燈

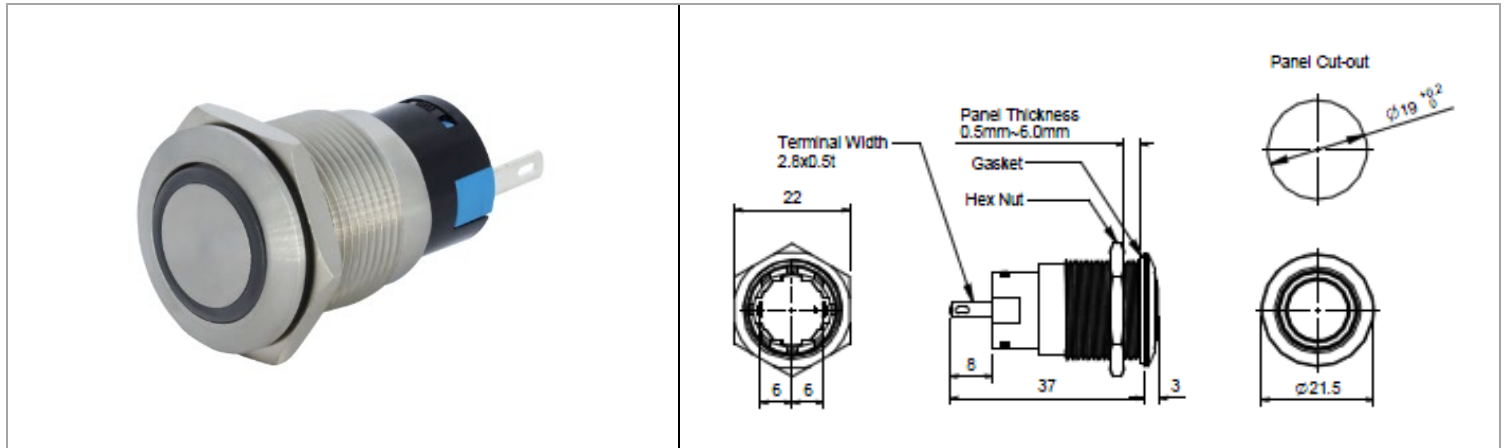

目錄僅供參考，實際規格仍依照產品工程圖面為準

產品介紹 Product Description

F24L1-	□	□	□	□	□	□	□	□	□	□□
Function	IP	Contacts	LED Voltage	LED Color	Plastic Bezel	Material Finish	Metal Bezel	Lens Color	Mark	
N: None	2:IP67	1:1LED 2Terminal	2: 6V 3: 12V 4: 24V	G: Green R: Red A: Amber B: Blue W: White	F: Flush P: Prominent D: Domed	S: Stainless Steel P: Brushed Stainless Steel A: Aluminum B: Black Aluminum	blank:Standard	0: None G: Green R: Red A: Amber B: Blue	00: None 01: Dot 02: Ring	

技術規格 Technical Data

LED Life (reference value)	50,000 hours (a)
Rated voltage	AC/DC
Operating Humidity	45 to 85% RH (no condensation)
Storage Temperature	- 30 to +80°C (no freezing)
Operating Temperature	- 25 to +50°C (no freezing)
Terminal Style	Solder terminal
Torque (max)	3.5Nm
Weight (approx.)	21g/13g (Stainless Steel/Aluminum)
Degree of protection	IP67

Note:

(a) Brightness of LED lamp will half of the initial value when using DC only