

ODFBS 5-8

端子台 > 軌道端子台

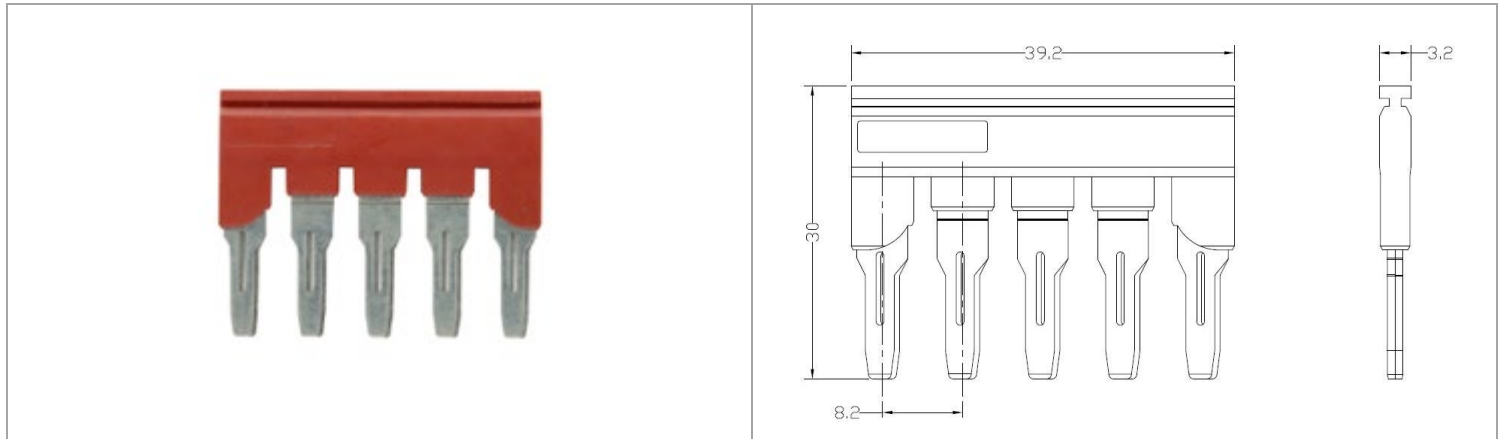

目錄僅供參考，實際規格仍依照產品工程圖面為準

產品介紹 Product Description

商務資料 Key Commercial Data

包裝單位 Packing unit	1 PCS
MOQ Minimum order quantity	50PCS
條碼GTIN	
產品重量 Weight per Piece (excluding packing)	9.54g
訂貨碼 Custom tariff number	
原產地Country of origin	CN

材料資訊 Material information

絕緣材料Insulating material	PA66
符合UL 94的可燃性等級 Flammability rating according to UL 94	V0
產品顏色 Color	
最大工作溫度°C Continuous operating temp., max.	105°C
最小工作溫度°C Continuous operating temp., min.	-40°C

外型尺寸 Dimensions

寬度 Width	3.20mm
長度Length	39.20mm
高度Height	30.00mm
間距	8.20mm

一般資訊 General information

產品電位Potentials	5
應用軌道端子 Terminal Blocks of application	DPT6 ; DPT6-PE ; DPT6/3 ; DPT6/3-PE ; DPT6/4 ; DPT6/4-PE
最大負載電流 Maximum load current	43A

環保產品合規 Environmental Product Compliance

China RoHS	
RoHS Compliant	