

## SDU10/3

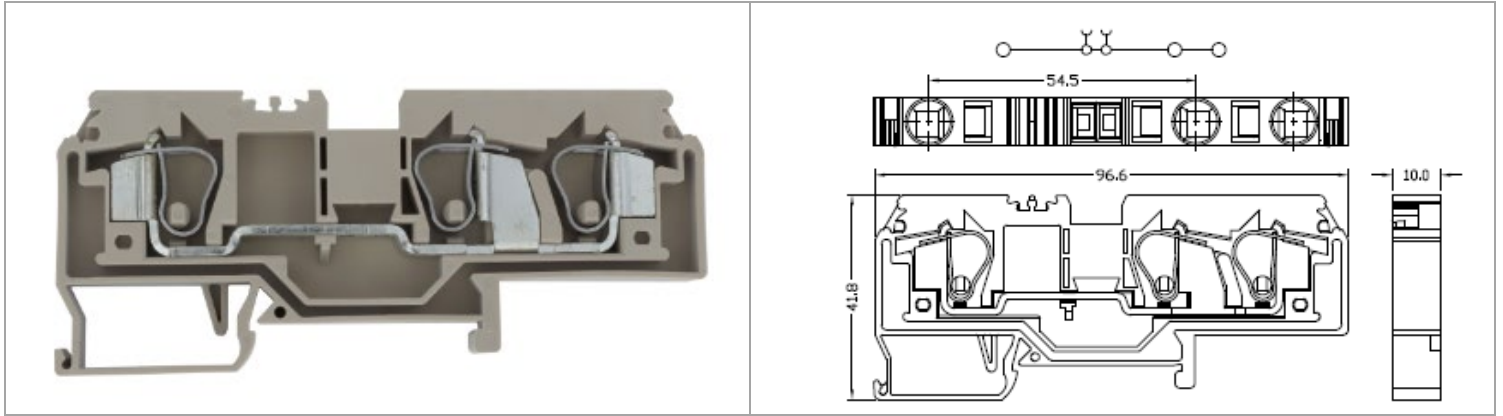

目錄僅供參考，實際規格仍依照產品工程圖面為準

### 產品介紹 Product Description

### 標準法規 Standards and Regulations

#### IEC連接數據 IEC Connection data (60947-7-1)

額定電壓 (V) Rated voltage (V)	800
額定電流 (A) Rated current (A)	57
導線橫截面積 (mm <sup>2</sup> ) Conductor cross section (mm <sup>2</sup> )	0.2mm <sup>2</sup> ~ 10mm <sup>2</sup>

#### CSA連接數據 CSA Connection data

額定電壓 (V) Rated voltage (V)	600
額定電流 (A) Rated current (A)	38
線徑範圍 (AWG) Wire Range (AWG)	24~8

#### UL連接數據 UL Connection data

額定電壓 (V) Rated voltage (V)	600
額定電流 (A) Rated current (A)	38
線徑範圍 (AWG) Wire Range (AWG)	24~8

#### CUL連接數據 CUL Connection data

額定電壓 (V) Rated voltage (V)	600
額定電流 (A) Rated current (A)	38
線徑範圍 (AWG) Wire Range (AWG)	24~8

### 商務資料 Key Commercial Data

包裝單位 Packing unit	1 PCS
MOQ Minimum order quantity	50 PCS
條碼GTIN	
產品重量 Weight per Piece (excluding packing)	32.2 g
訂貨碼 Custom tariff number	
原產地Country of origin	CN

### 材料資訊 Material information

絕緣材料 Insulating material	PA66
符合UL 94的可燃性等級 Flammability rating according to UL 94	V0
產品顏色 Color	Beige

最大工作溫度°C Continuous operating temp., max.	105°C
最小工作溫度°C Continuous operating temp., min.	-40°C

## 外型尺寸 Dimensions

寬度 Width	96.6 mm
長度 Length	10 mm
高度 Height	41.8 mm
高度 Height NS 35/7,5	42.3 mm
高度 Height NS 35/15	49.8 mm

## 一般資訊 General information

產品連接數 Number of connections	3
產品電位 Potentials	1
標籤寬度 Nominal cross section	6mm
安裝指導 Installation Advice	Rail Mounting(導軌安裝)
應用領域 Area of application	機電工程
	能源工程
	機械工程
	運輸工程
	自動工程
軌道條 Type of mounting	TS35/7.5
	TS35/15
額定浪湧電壓 Rated surge voltage	8 Kv
汙染程度 Degree of pollution	3
過電壓類別 Overvoltage category	III
絕緣材料組 Insulating material group	I
額定電流 Nominal current IN	38
額定電壓 Nominal voltage UN	600
側邊為開放式 Open side panel	yes
手背防護 Back of the hand protection	guaranteed
手指保護 Finger protection	guaranteed

## 連接數據 Connection data

連接 Connection	1
連接方式 Connection method	Cage clamp
撥線長度 Stripping length	15~16 mm
針對管狀端頭 H1/10 和 H1.5/10 須應用的剝線長度 For the wire end ferrules H1/10 and H1.5/10 of stripping length is to apply.	15~16 mm
導線連接截面積，多股導線，帶管狀端頭 DIN 46228/1 Wire connection cross-section, stranded conductor with wire-end ferrules DIN 46228/1	6 mm <sup>2</sup>
導線連接截面積，多股導線，帶管狀端頭 DIN 46228/4 Wire connection cross-section, stranded conductor with wire-end ferrules DIN 46228/4	6 mm <sup>2</sup>
螺絲刀口尺寸 Blade size	0.8 x 4 mm

## 環保產品合規 Environmental Product Compliance

China RoHS	
------------	--

**RoHS**  
Compliant