

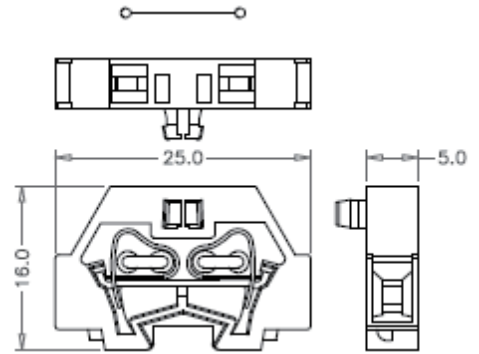

SDUB1.5-A



目錄僅供參考，實際規格仍依照產品工程圖面為準

產品介紹 Product Description

標準法規 Standards and Regulations

IEC 連接數據 IEC Connection data (60947-7-1)		CE
額定電壓 (V) Rated voltage (V)	400	
額定電流 (A) Rated current (A)	17.5	
導線橫截面積 (mm ²) Conductor cross section (mm ²)	0.2mm ² ~ 1.5mm ²	
CSA 連接數據 CSA Connection data		
額定電壓 (V) Rated voltage (V)	300	
額定電流 (A) Rated current (A)	15	
線徑範圍 (AWG) Wire Range (AWG)	28~16	
VDE 連接數據 VDE Connection data		
額定電壓 (V) Rated voltage (V)	400	
額定電流 (A) Rated current (A)	17.5	
線徑範圍 (AWG) Wire Range (AWG)	0.2mm ² ~ 1.5mm ²	
UL 連接數據 UL Connection data		
額定電壓 (V) Rated voltage (V)	300	
額定電流 (A) Rated current (A)	10	
線徑範圍 (AWG) Wire Range (AWG)	28~16	
CUL 連接數據 CUL Connection data		
額定電壓 (V) Rated voltage (V)	300	
額定電流 (A) Rated current (A)	10	
線徑範圍 (AWG) Wire Range (AWG)	28~16	
商務資料 Key Commercial Data		
包裝單位 Packing unit	1 PCS	
MOQ Minimum order quantity	25 PCS	
條碼 GTIN		
產品重量 Weight per Piece (excluding packing)	1.4 g	

訂貨碼 Custom tariff number	
原產地 Country of origin	CN

材料資訊 Material information

絕緣材料 Insulating material	PA66
符合UL 94的可燃性等級 Flammability rating according to UL 94	V0
產品顏色 Color	
最大工作溫度 °C Continuous operating temp., max.	105°C
最小工作溫度 °C Continuous operating temp., min.	-40°C

外型尺寸 Dimensions

寬度 Width	25 mm
長度 Length	5 mm
高度 Height	16 mm

一般資訊 General information

產品連接數 Number of connections	2
產品電位 Potentials	1
安裝指導 Installation Advice	With anap-in mounting foot; for plate thickness 0.6-1.2mm ;fixing 3.5mm φ 帶有嵌入式安裝腳，適用於板厚度0.6-1.2mm，固定孔3.5mm φ
應用領域 Area of application	機電工程 能源工程 機械工程 運輸工程 自動工程
額定浪湧電壓 Rated surge voltage	6 Kv
汙染程度 Degree of pollution	3
過電壓類別 Overvoltage category	III
絕緣材料組 Insulating material group	I
側邊為開放式 Open side panel	yes
手背防護 Back of the hand protection	guaranteed
手指保護 Finger protection	guaranteed

連接數據 Connection data

連接 Connection	1
連接方式 Connection method	Cage clamp
撥線長度 Stripping length	8~9 mm
針對管狀端頭 H1/10 和 H1.5/10 須應用的剝線長度 For the wire end ferrules H1/10 and H1.5/10 of stripping length is to apply.	8~9 mm
導線連接截面積，多股導線，帶管狀端頭 DIN 46228/1 Wire connection cross-section, stranded conductor with wire-end ferrules DIN 46228/1	1.5 mm ²
導線連接截面積，多股導線，帶管狀端頭 DIN 46228/4 Wire connection cross-section, stranded conductor with wire-end ferrules DIN 46228/4	1.5 mm ²
螺絲刀口尺寸 Blade size	0.5 x 3mm

環保產品合規 Environmental Product Compliance

China RoHS	
------------	--

RoHS
Compliant

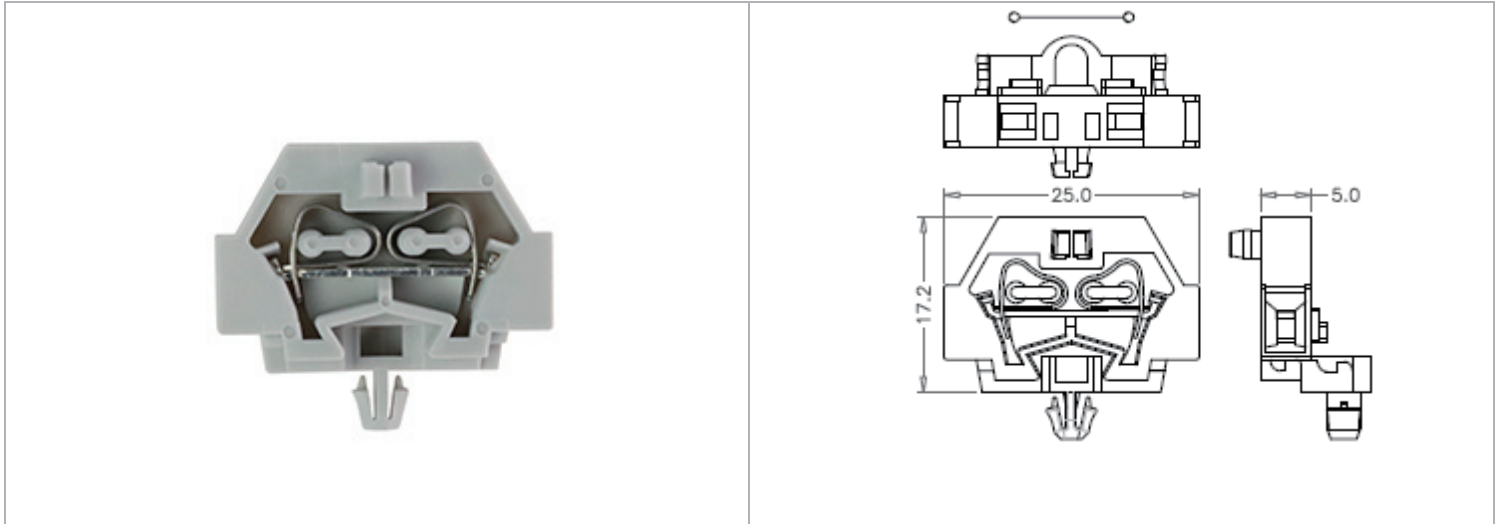

SDUB1.5-B



目錄僅供參考，實際規格仍依照產品工程圖面為準

產品介紹 Product Description

標準法規 Standards and Regulations

IEC 連接數據 IEC Connection data (60947-7-1)		CE
額定電壓 (V) Rated voltage (V)	400	
額定電流 (A) Rated current (A)	17.5	
導線橫截面積 (mm ²) Conductor cross section (mm ²)	0.2mm ² ~ 1.5mm ²	
CSA 連接數據 CSA Connection data		
額定電壓 (V) Rated voltage (V)	300	
額定電流 (A) Rated current (A)	15	
線徑範圍 (AWG) Wire Range (AWG)	28~16	
VDE 連接數據 VDE Connection data		
額定電壓 (V) Rated voltage (V)	400	
額定電流 (A) Rated current (A)	17.5	
線徑範圍 (AWG) Wire Range (AWG)	0.2mm ² ~ 1.5mm ²	
UL 連接數據 UL Connection data		
額定電壓 (V) Rated voltage (V)	300	
額定電流 (A) Rated current (A)	10	
線徑範圍 (AWG) Wire Range (AWG)	28~16	
CUL 連接數據 CUL Connection data		
額定電壓 (V) Rated voltage (V)	300	
額定電流 (A) Rated current (A)	10	
線徑範圍 (AWG) Wire Range (AWG)	28~16	
商務資料 Key Commercial Data		
包裝單位 Packing unit	1 PCS	
MOQ Minimum order quantity	25 PCS	
條碼GTIN		
產品重量 Weight per Piece (excluding packing)	1.6 g	

訂貨碼 Custom tariff number	
原產地Country of origin	CN

材料資訊 Material information

絕緣材料Insulating material	PA66
符合UL 94的可燃性等級 Flammability rating according to UL 94	V0
產品顏色 Color	
最大工作溫度°C Continuous operating temp., max.	105°C
最小工作溫度°C Continuous operating temp., min.	-40°C

外型尺寸 Dimensions

寬度 Width	25 mm
長度Length	5 mm
高度Height	17.2 mm

一般資訊 General information

產品連接數Number of connections	2
產品電位Potentials	1
安裝指導Installation Advice	With anap-in mounting foot; for plate thickness 0.6-1.2mm ;fixing 3.5mm φ 帶有嵌入式安裝腳，適用於板厚度0.6-1.2mm，固定孔3.5mm φ
應用領域 Area of application	機電工程
	能源工程
	機械工程
	運輸工程
	自動工程
額定浪湧電壓 Rated surge voltage	6 Kv
汙染程度 Degree of pollution	3
過電壓類別 Overvoltage category	III
絕緣材料組 Insulating material group	I
側邊為開放式 Open side panel	yes
手背防護Back of the hand protection	guaranteed
手指保護 Finger protection	guaranteed

連接數據 Connection data

連接 Connection	1
連接方式Connection method	Cage clamp
撥線長度Stripping length	8~9 mm
針對管狀端頭H1/10和H1.5/10須應用的剝線長度 For the wire end ferrules H1/10 and H1.5/10 of stripping length is to apply.	8~9 mm
導線連接截面積，多股導線，帶管狀端頭 DIN 46228/1 Wire connection cross-section, stranded conductor with wire-end ferrules DIN 46228/1	1.5 mm ²
導線連接截面積，多股導線，帶管狀端頭 DIN 46228/4 Wire connection cross-section, stranded conductor with wire-end ferrules DIN 46228/4	1.5 mm ²
螺絲刀口尺寸 Blade size	0.5 x 3mm

環保產品合規 Environmental Product Compliance

China RoHS	
------------	--

RoHS
Compliant

SDUB1.5-C

軌道式接線端子 > 配件 > 擋板

Din rail Terminal blocks > Accessories > End Plate

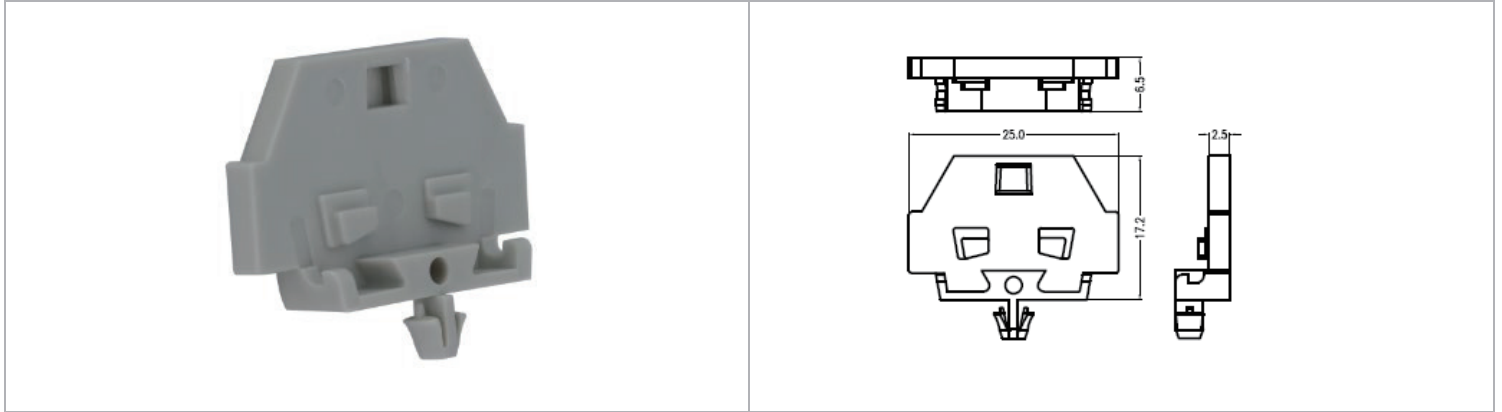

目錄僅供參考，實際規格仍依照產品工程圖面為準

產品介紹 Product Description

商務資料 Key Commercial Data

包裝單位 Packing unit	50 PCS
MOQ Minimum order quantity	50 PCS
條碼GTIN	
產品重量 Weight per Piece (excluding packing)	1.23 g
訂貨碼 Custom tariff number	
原產地Country of origin	CN

材料資訊 Material information

絕緣材料 Insulating material	PA66
符合UL 94的可燃性等級 Flammability rating according to UL 94	V0
產品顏色 Color	Gray
導體材質 Terminal	Copper
最大工作溫度°C Continuous operating temp., max.	105°C
最小工作溫度°C Continuous operating temp., min.	-40°C

環保產品合規 Environmental Product Compliance

China RoHS	
------------	--

RoHS
Compliant